

Data Sheet



Article number: 03445200

Description: Fluro Heavy Duty Spherical Plain Bearing GE 200 EW-2RS
Hole \varnothing 200

Note: 200

Measures

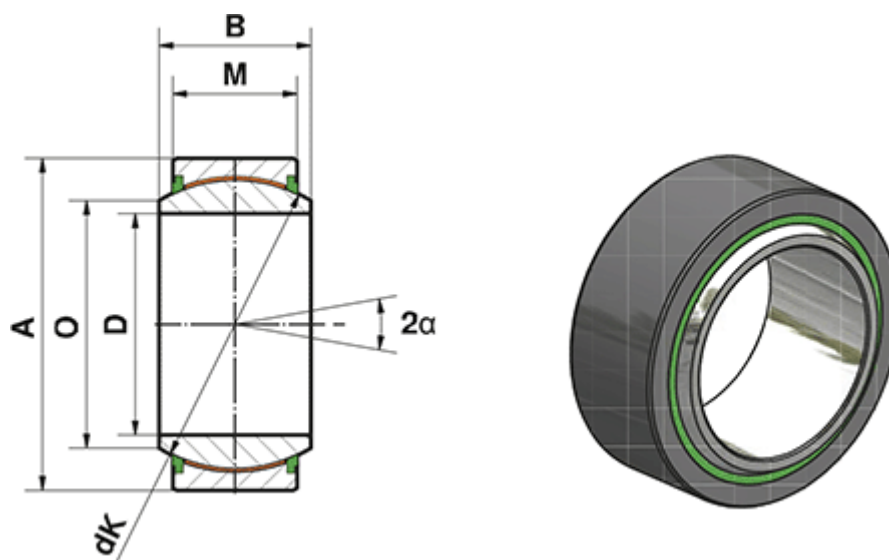

A	= 290	Static load C0 (kN) = 10000
a (degrees)	= 7	Weight (g) = 28000
B	= 130	
D	= 200	
dK	= 250	
Dynamic load C (kN)	= 6000	
M	= 100	
O	= 213.5	